

PFERDESTALL

STABLE
ÉCURIE

PAARDENSTAL



Art. Nr. 130541

D

Vor Beginn des Bastelns sollten Sie sich mit den Spritzlingen und der Anleitung vertraut machen. Sollte es einmal vorkommen, dass ein Teil im Bausatz fehlt, kreuzen Sie bitte das fehlende Teil in der Anleitung an und schicken Sie diese bitte an Fa. Gebr. FALLER GmbH, Abt. Kundendienst, kundendienst@faller.de, Kreuzstraße 9, 78148 Gütenbach. Sie erhalten dann umgehend Ersatz. In diesem Bausatz sind einige Kunststoffteile übrig.

GB

Before beginning with the assembly please familiarize yourself with the parts and read the instructions carefully. In case of missing parts please indicate these on the instructions leaflet with a circle and return the leaflet to Gebr. FALLER GmbH, kundendienst@faller.de, Kreuzstraße 9, D-78148 Gütenbach, Germany. You will receive the replacement by return. Some of the parts in this box are not needed to construct the model.

F

Avant de commencer le montage de votre maquette bien lire la notice et repérer les grappes. Si une pièce manque dans une boîte, cochez la pièce correspondante sur la notice et renvoyez-la-nous à Gebr. FALLER GmbH, kundendienst@faller.de, Kreuzstraße 9, D-78148 Gütenbach (R.F.A.). Nous vous ferons parvenir la pièce par retour. Dans cette boîte se trouvent quelques pièces qui ne seront pas utilisées pour le montage.

NL

Vóór het bouwen zou men de gietstukken en de handleiding moeten bestuderen. Indien onverhoopt een onderdeel aan het bouwpakket ontbreekt, gelieve men het ontbrekende deel in de handleiding aan te kruisen en deze te zenden aan Gebr. FALLER GmbH, kundendienst@faller.de, Kreuzstraße 9, D-78148 Gütenbach. U ontvangt dan omgaand en gratis het ontbrekende onderdeel. Van dit bouwpakket worden enkele kunststof delen niet gebruikt.

Für den Zusammenbau des Modells empfehlen wir folgende FALLER-Artikel (sind nicht im Bausatz enthalten):
For the assembly of the kit we recommend following FALLER products (not included in the kit):
Pour l'assemblage du modèle, nous vous recommandons les articles FALLER suivants (non inclus dans le kit):
Om dit model te bouwen adviseren wij de volgende FALLER producten (maken geen deel uit van deze bouwset):



Art. Nr. 170492
FALLER-EXPERT

Flüssigkleber in Plastikflasche mit Spezialkanüle für Feinste Klebstoffdosierung.

Liquid cement in plastic bottle with canule for very fine dosage.

Colle liquide en bouteille plastique avec bec verseur pour un dosage précis.

Vloeibare lijm in plastic-flescon met doseerbuisje om nauwkeurig te lijmen.



Art. Nr. 170688
SPEZIAL-SEITENSCHNEIDER

zum gratfreien Abtrennen von feinsten Spritzteilen.
Nur für Polystyrol geeignet.

Special side cutter for cutting off ultra-fine moulded parts without burrs.
Only suitable for polystyrene.

Pince coupante spéciale pour couper sans bavure les pièces miniatures moulées par injection. Convient uniquement au polystyrène.

Speciale zijkniptang voor het braamloos afknippen van de fijnste gietstukdelen. Alleen geschikt voor polystyrol.

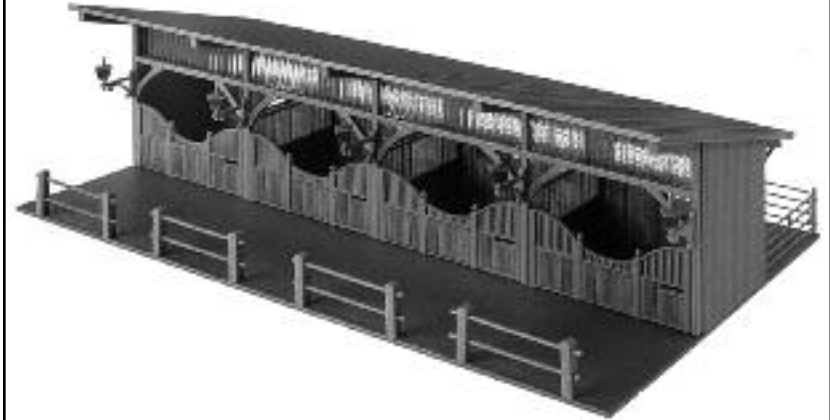

Inhalt Contents Contenu Inhoud	Spritzlinge	1 B 1 x	6 AB 1 x	8 C 1 x	21 C 1 x
	Sprues	3 1 x	6 C 2 x	8 D 1 x	22 2 x
	Moulages Gietstukken	6 A 1 x	7 A 1 x	21 A 1 x	26 B 4 x

Sa. Nr. 219 219 1

2 Fensterfolie
 Schnittmusterfolie für Fenster vom Trägermaterial abziehen und auf die Fensterfolie mit gleicher Größe blasenfrei aufbringen (**ohne Klebstoff!**).
 Die benötigten Fenster werden ausgeschnitten und **ohne Schnittmusterfolie** auf die Rückseite der Fensterrahmen geklebt (Position laut Anleitung).

Window foil
 Pull off pattern sheet for windows from carrier and apply it, bubble-free, to the window foil of the same size (**without any glue**).
 Cut out the required windows and glue them to the rear side of the window frame **without pattern sheet** (position as to instructions).

Feuille fenêtre
 Retirer la feuille matrice pour fenêtre du matériel support et l'appliquer sur la feuille-fenêtre de même dimension sans que des bulles ne se produisent (**sans colle**).
 Découper le nombre de fenêtres nécessaires et les coller **sans la feuille** modèle sur l'arrière des dormants (position selon instructions).

Raam folie
 Knippatroomfolie voor de ramen van schutblad afhalen en zonder blaasjes op het raam folie van dezelfde grootte aanbrengen (**niet lijmen!**).
 De benodigde ramen worden uitgeknipt en **zonder de knippatroomfolie** op de achterzijde van de raamkozijnen gelijmd (positie volgens handleiding).

Fensterschnittmuster

Art. Nr. 130541 Sa. Nr. 219 681 1



2	2	2	2	2	2	2	2
---	---	---	---	---	---	---	---

	1	1
	1	1
	1	1
	1	1

Vor Beginn des Bauens Variante auswählen:
 Select the required variant before starting to make the model:
 Avant le début du montage, choisir la variante:
 Voor afgaand aan de bouw variant selecteren:

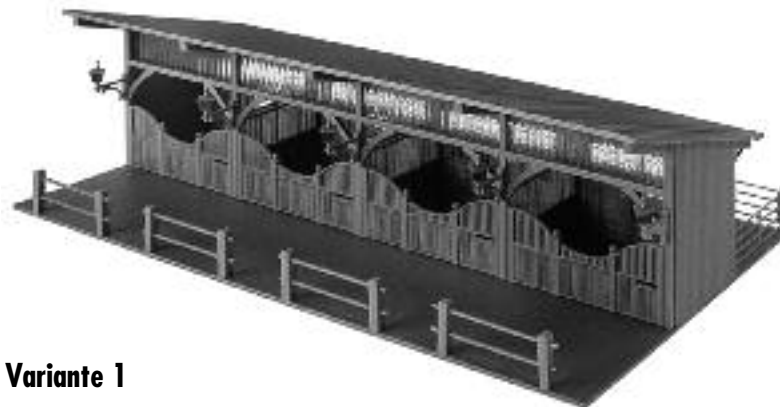

Variante 1

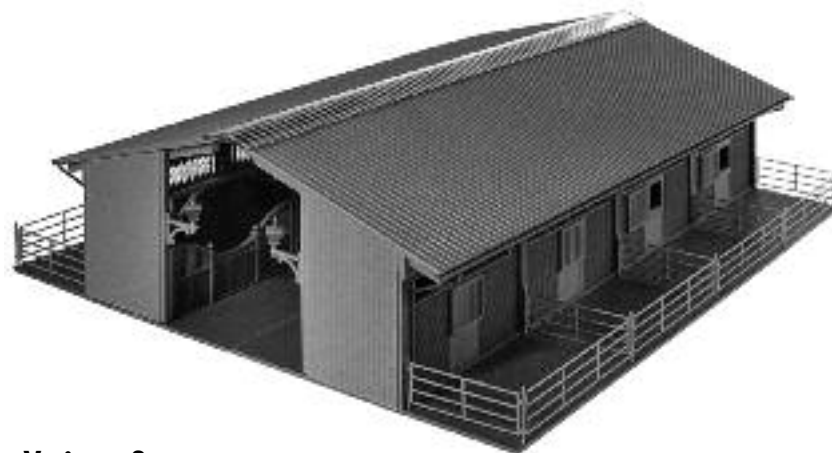

Variante 2:
2 x Art. 130541

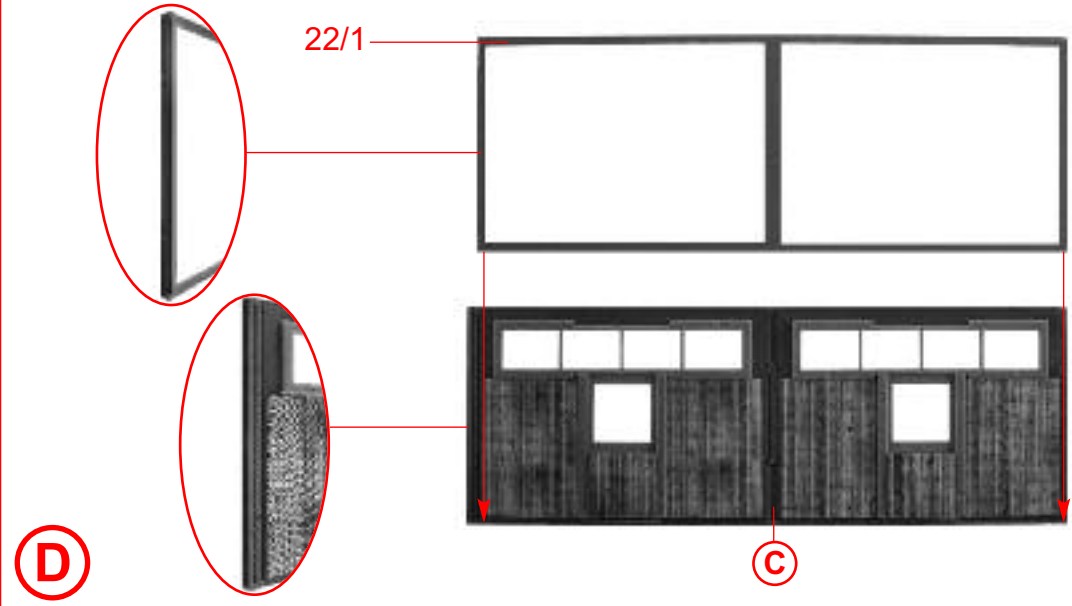
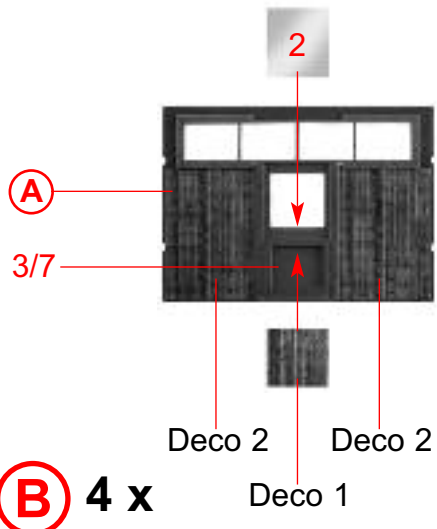
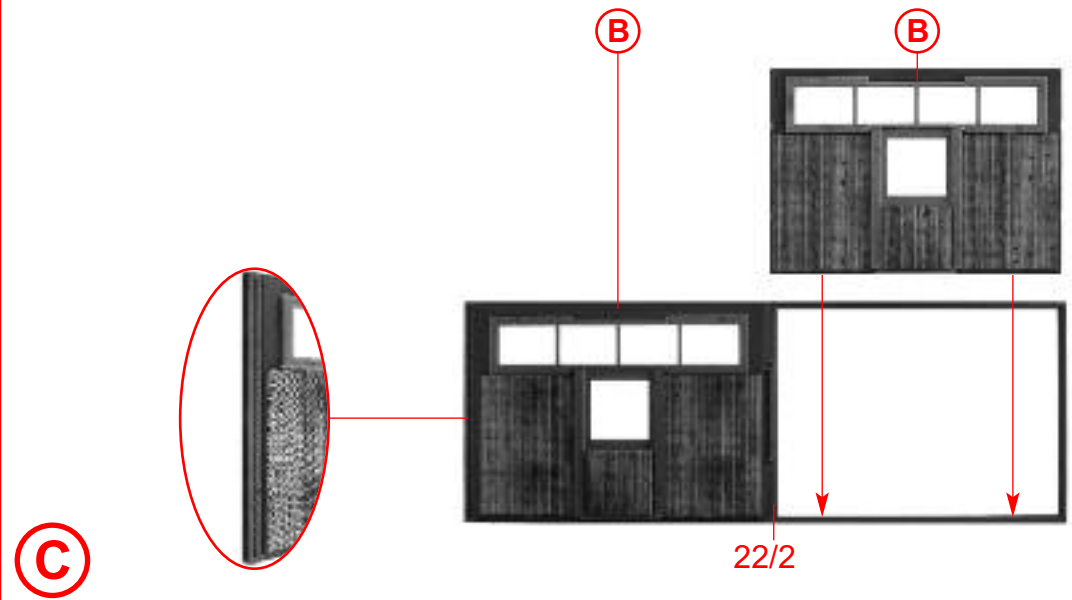
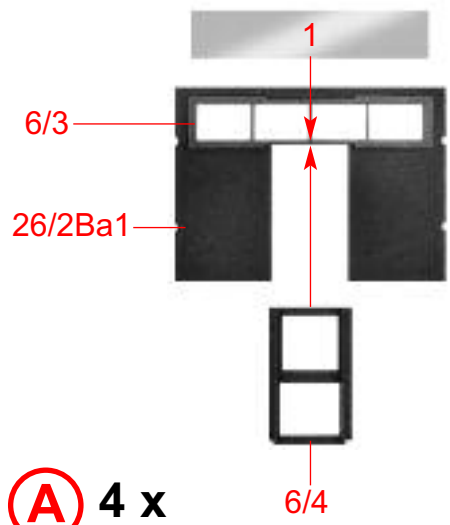

4

(B)

(B)

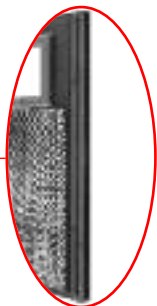
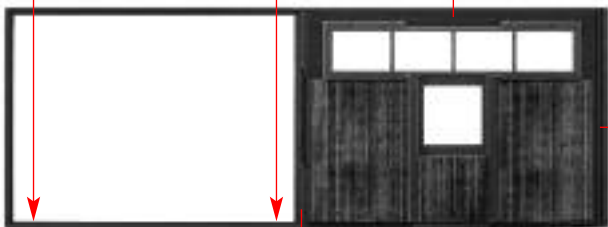
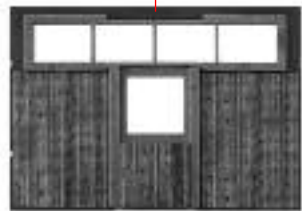

(E)

22/2

22/1

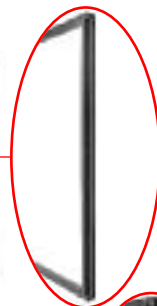

(F)

(E)

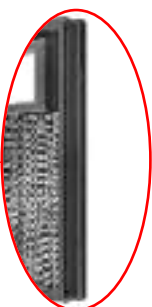
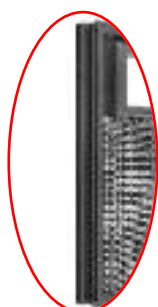

(G)

(D)

(F)

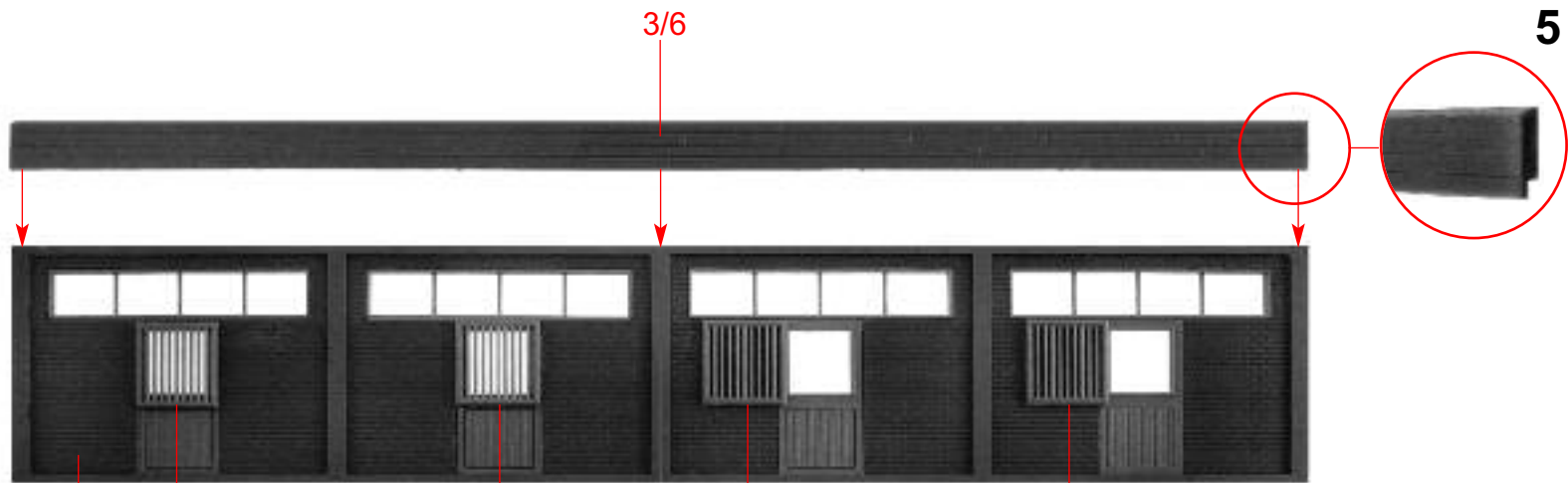

H

G

6/9

6/9

6/9

6/9

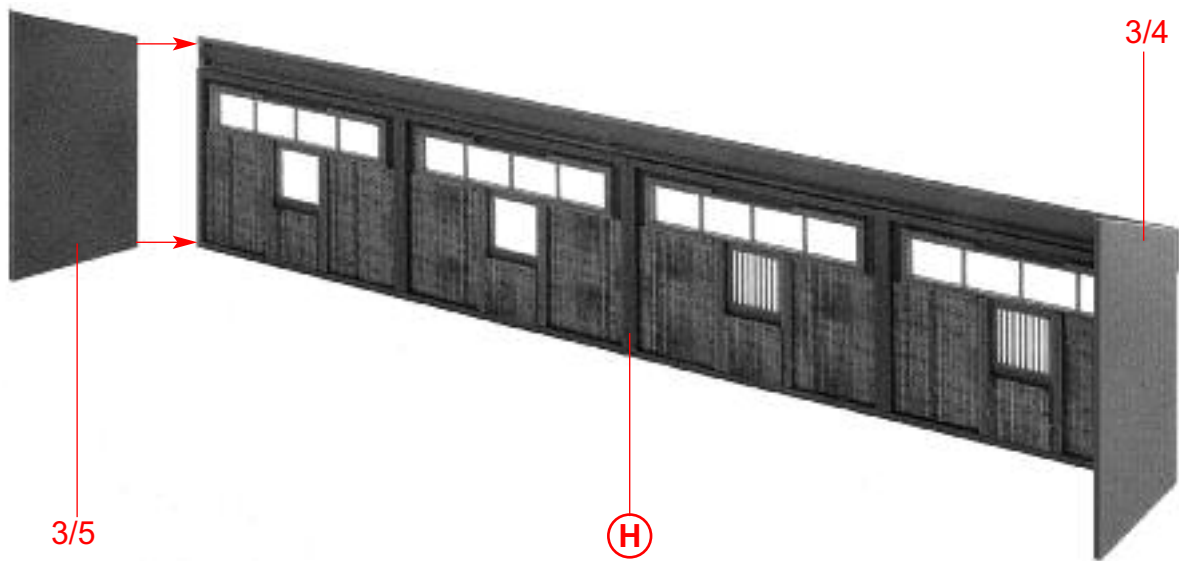

I

3/5

H

6

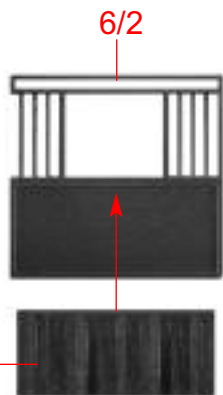

J 3 x Deco 28

J

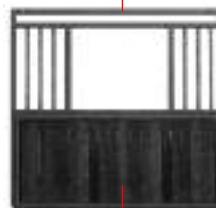

Deco 28

K 3 x

nur Variante 2 !!!

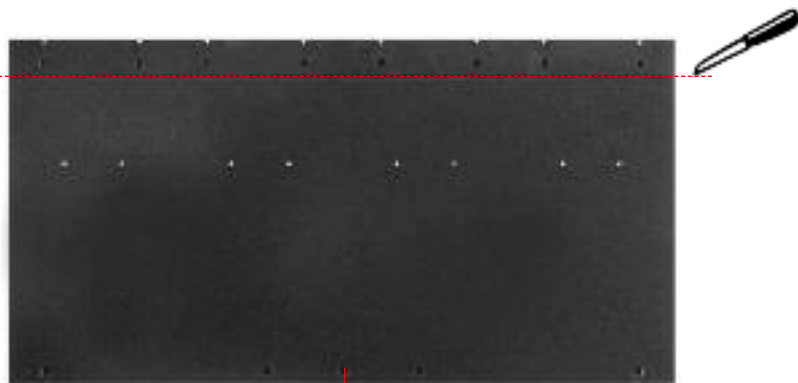

L

1/2

I

K

K

K

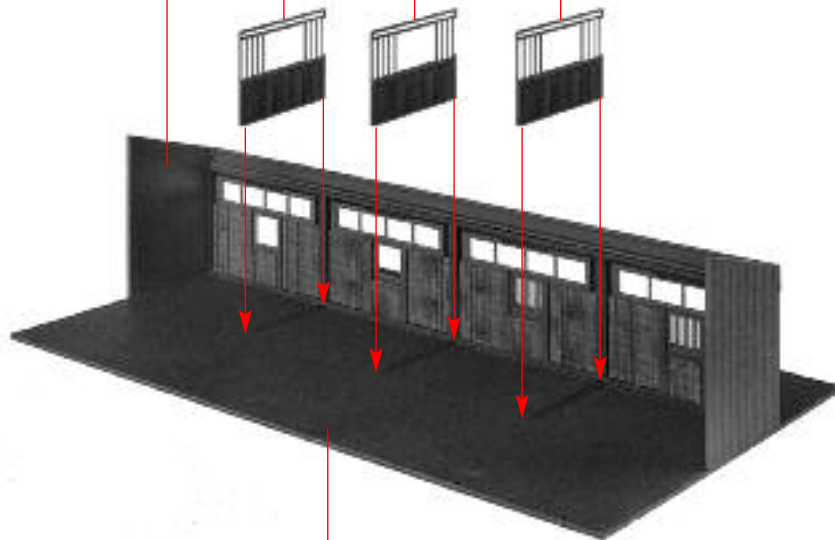

M

1/2 **L**

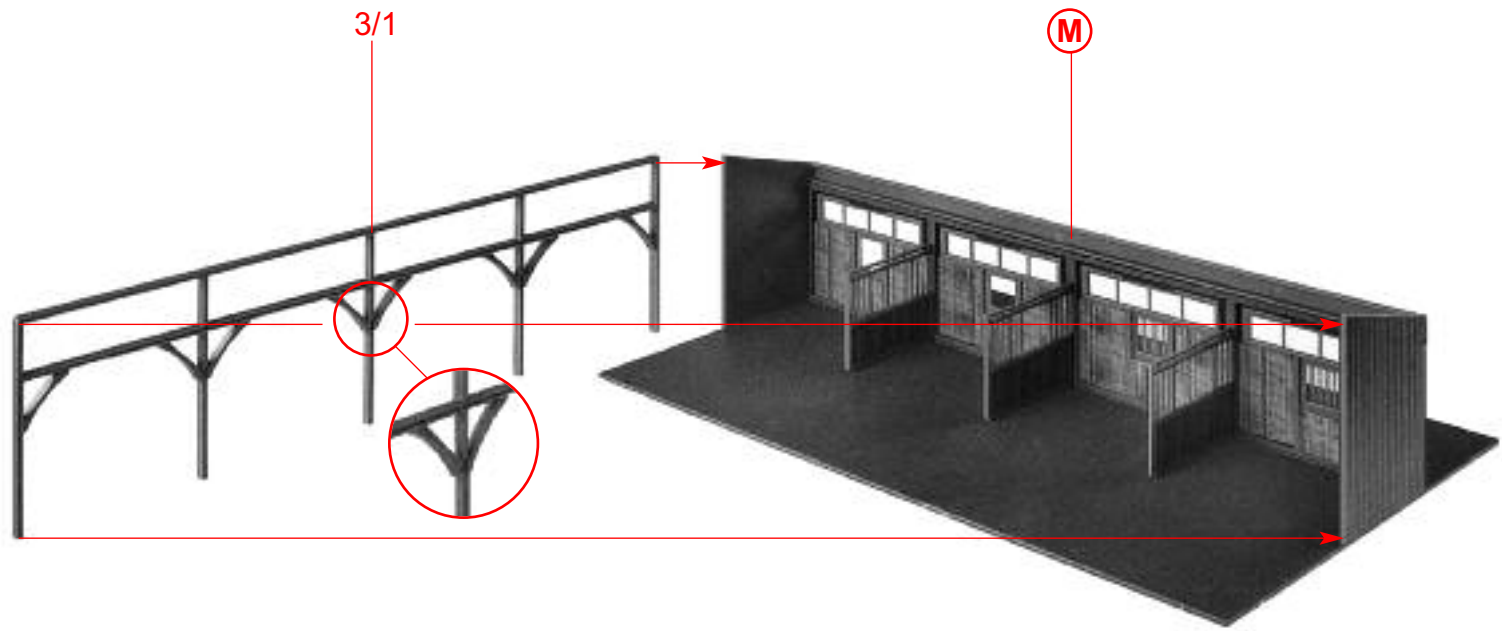

N

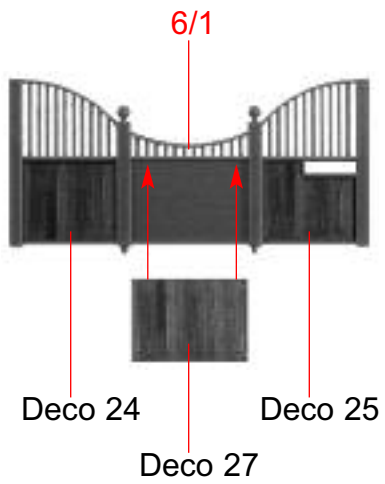

O 4 x

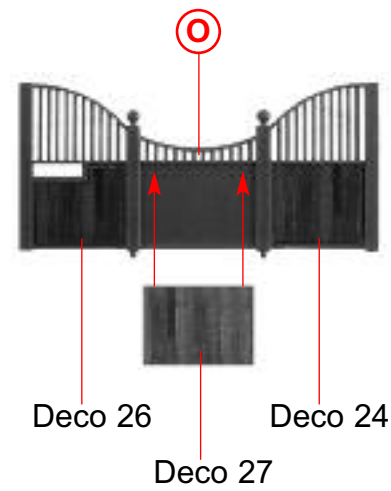

P 4 x

8

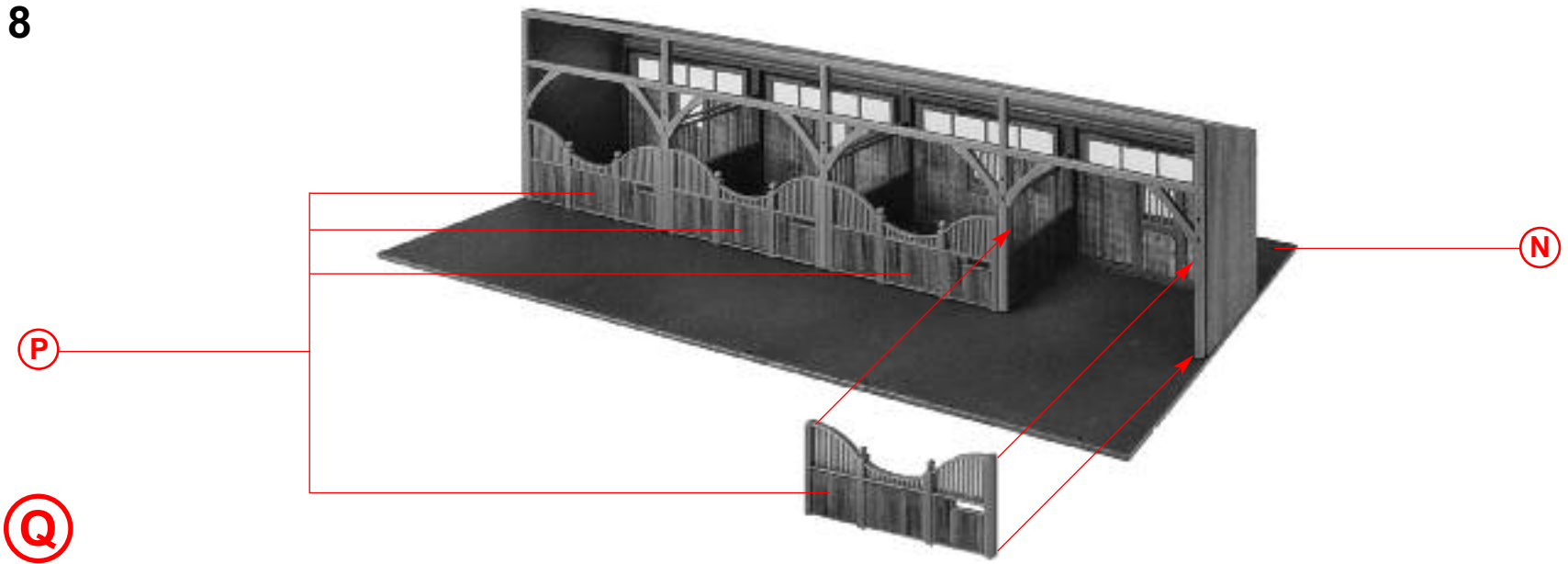

R 5 x

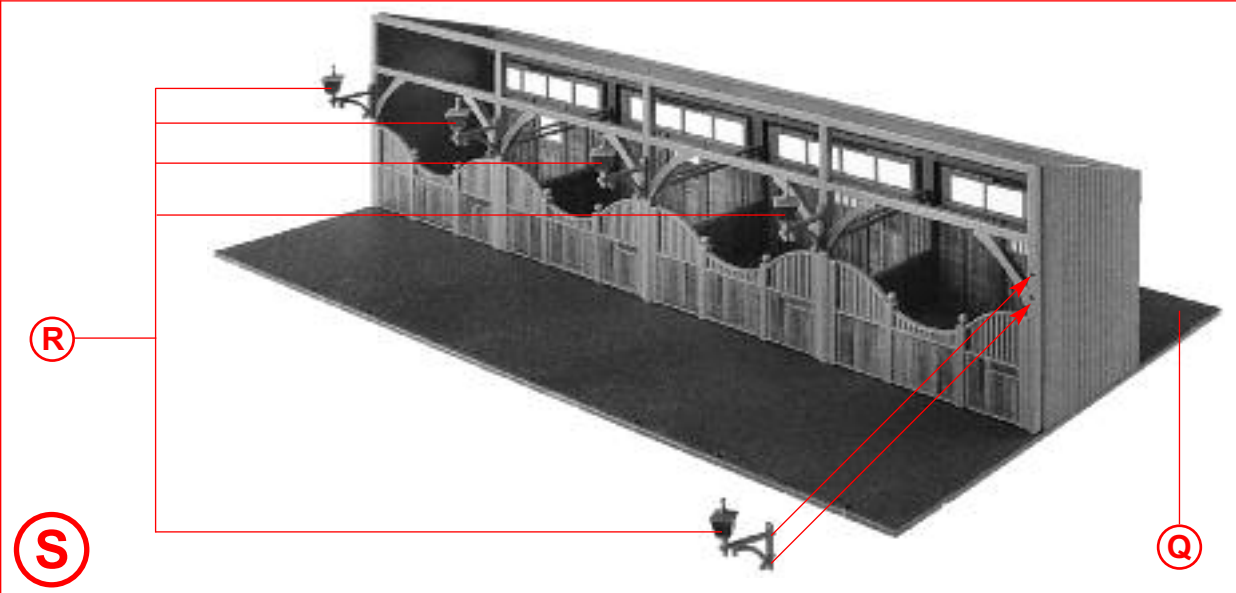

21/1

nur Variante 1

21/3

U 8 x ca. 40 mm

ca. 1 mm

nur Variante 1

T 8 x

V nur Variante 1

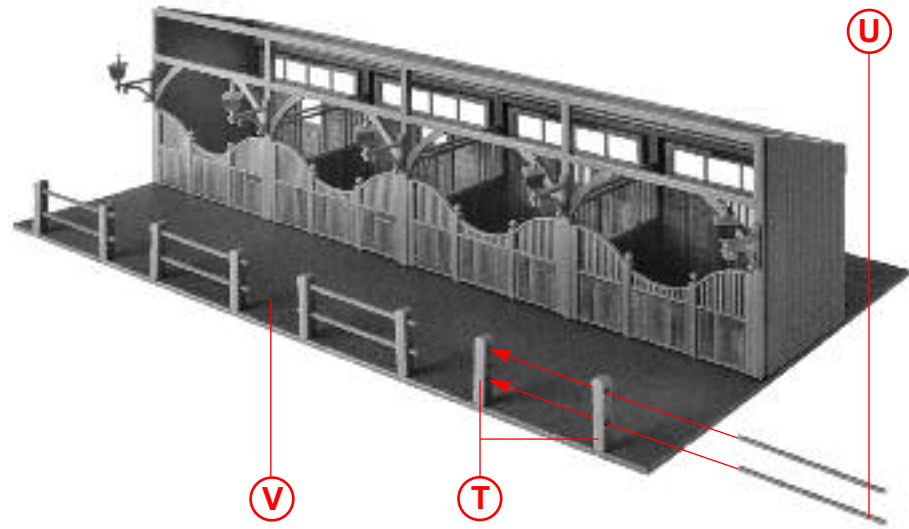
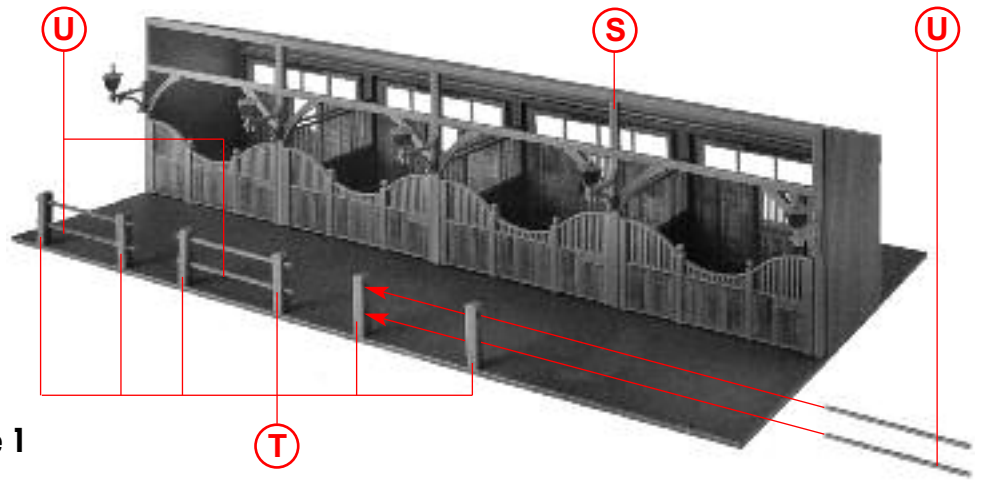

W nur Variante 1

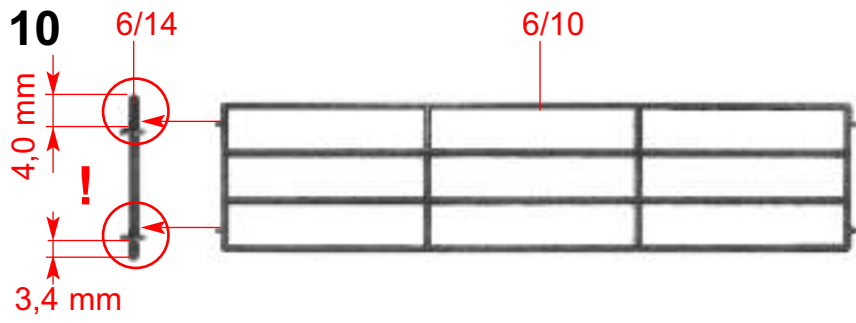

(X) 4 x

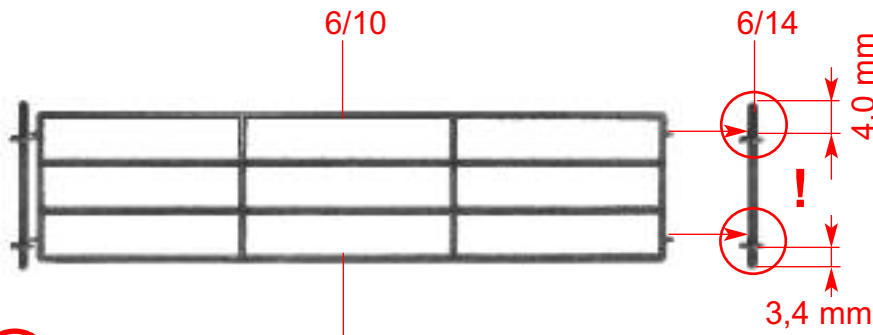

(a) 1 x

(X)

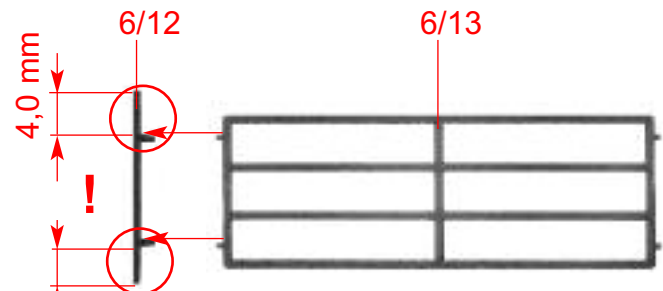

(b) 5 x

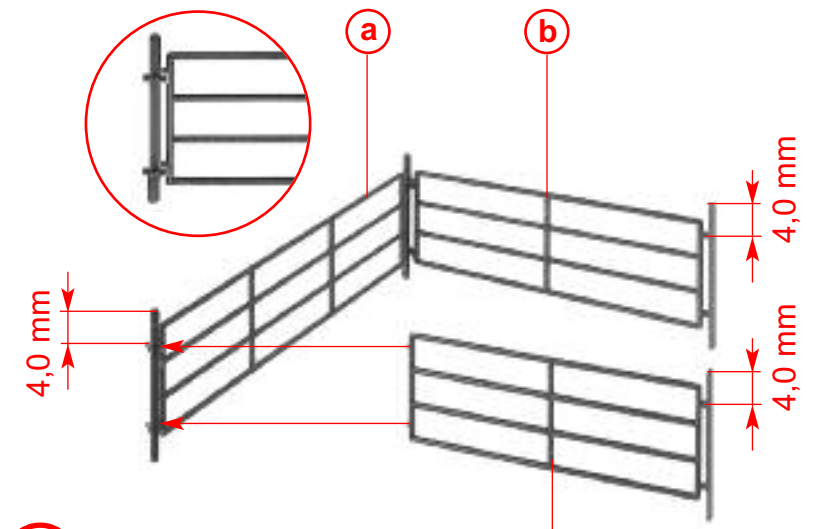

(c) 1 x

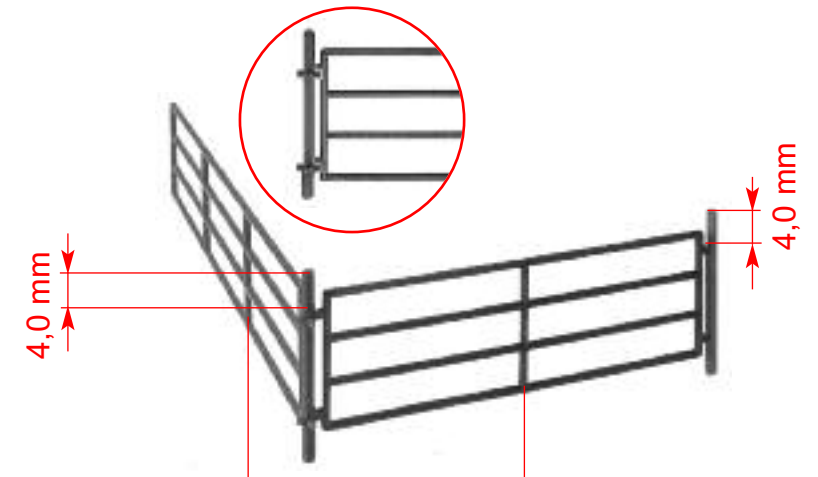

(d) 3 x

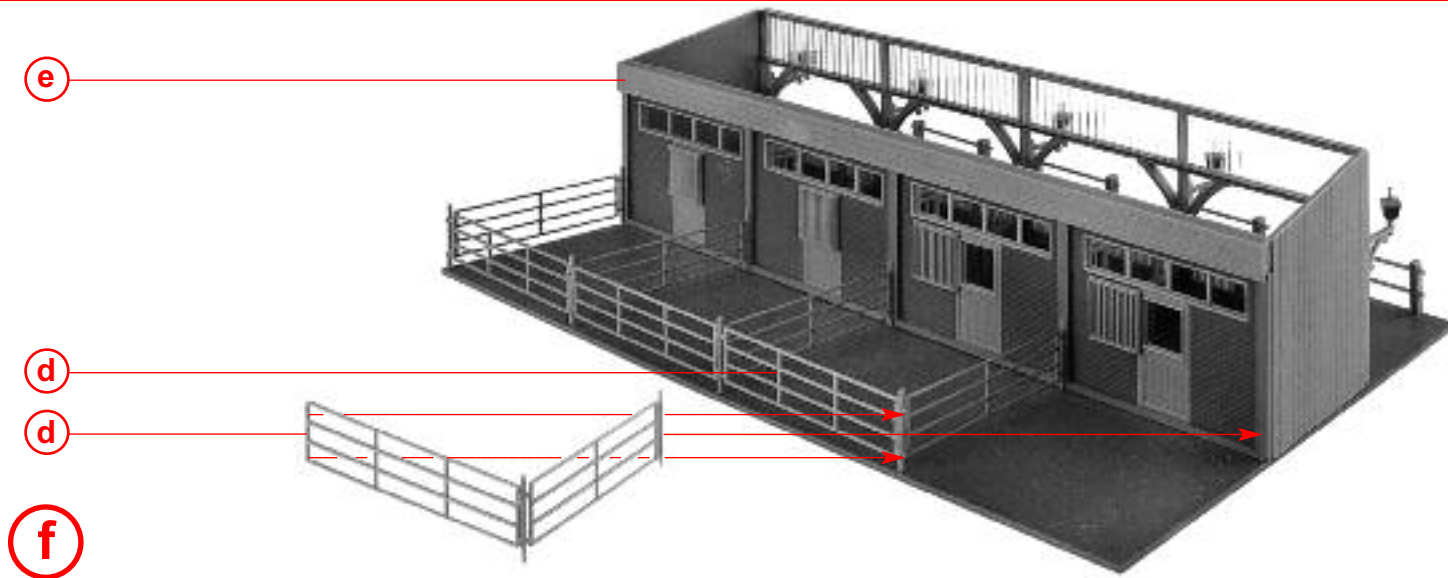
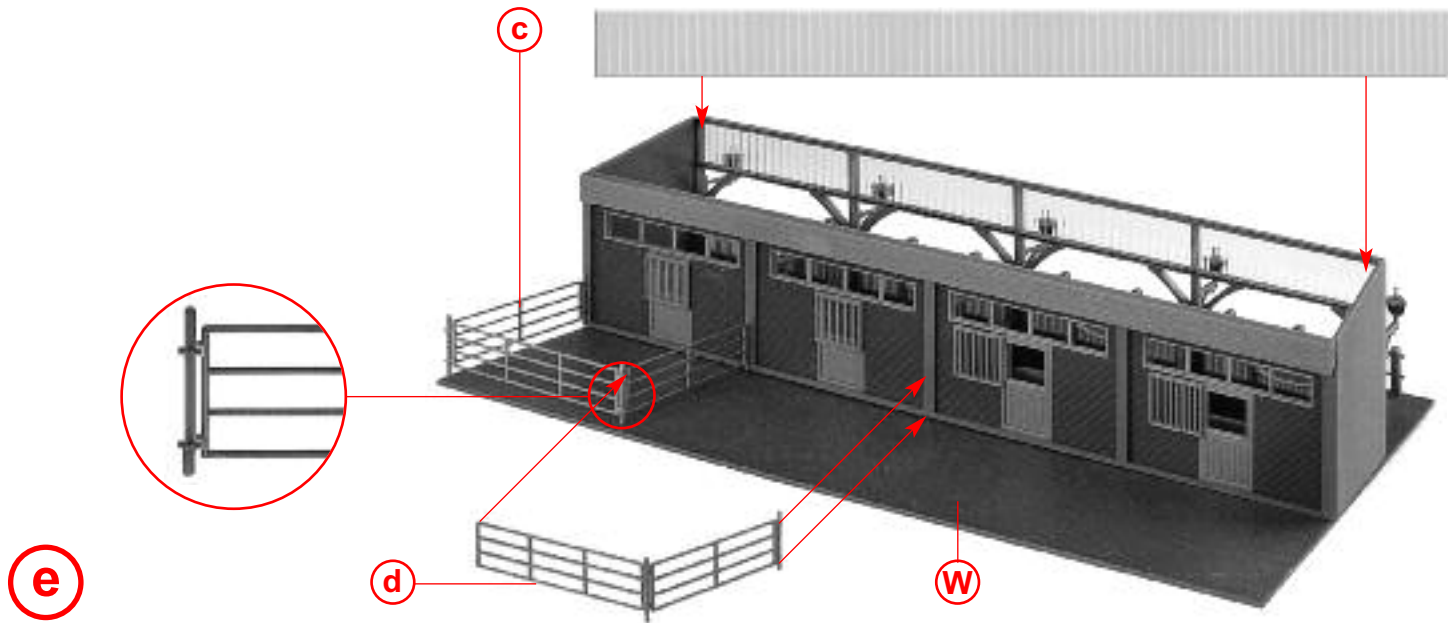

12

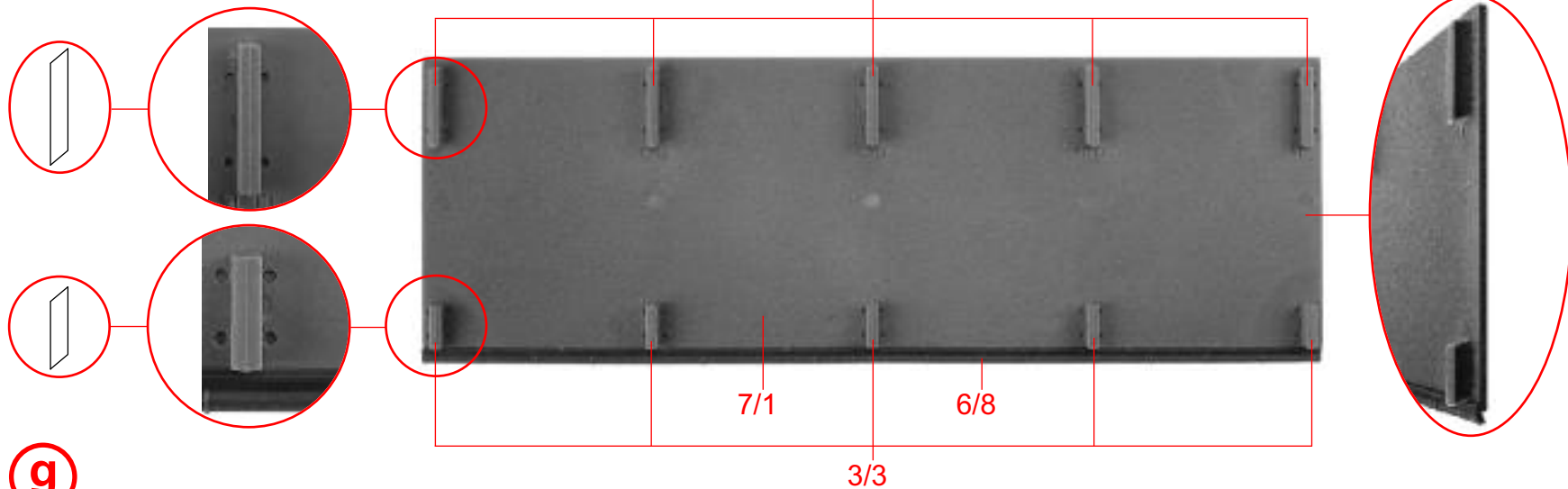

Art.-Nr. 180648 liegt nicht bei
not included
non jointe
niet bijgevoegd

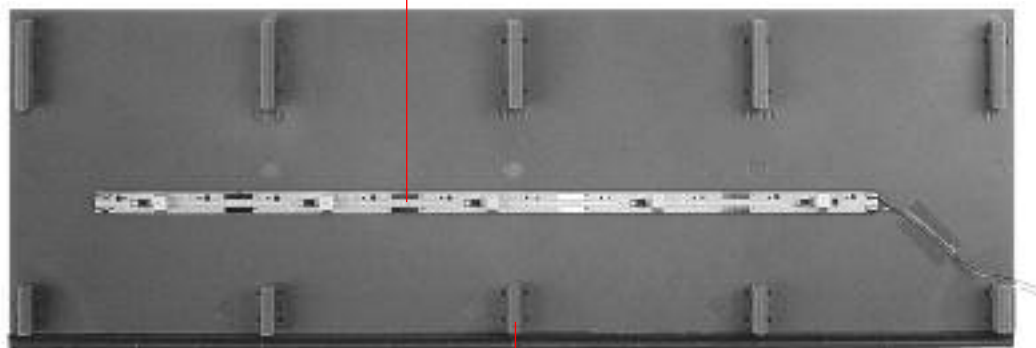

h

g

Loch mit \varnothing 2 mm bohren.
Drill hole with a dia. of 2 mm.
Percer un trou avec un diamètrede 2 mm.
Gat met \varnothing 2 mm boren.

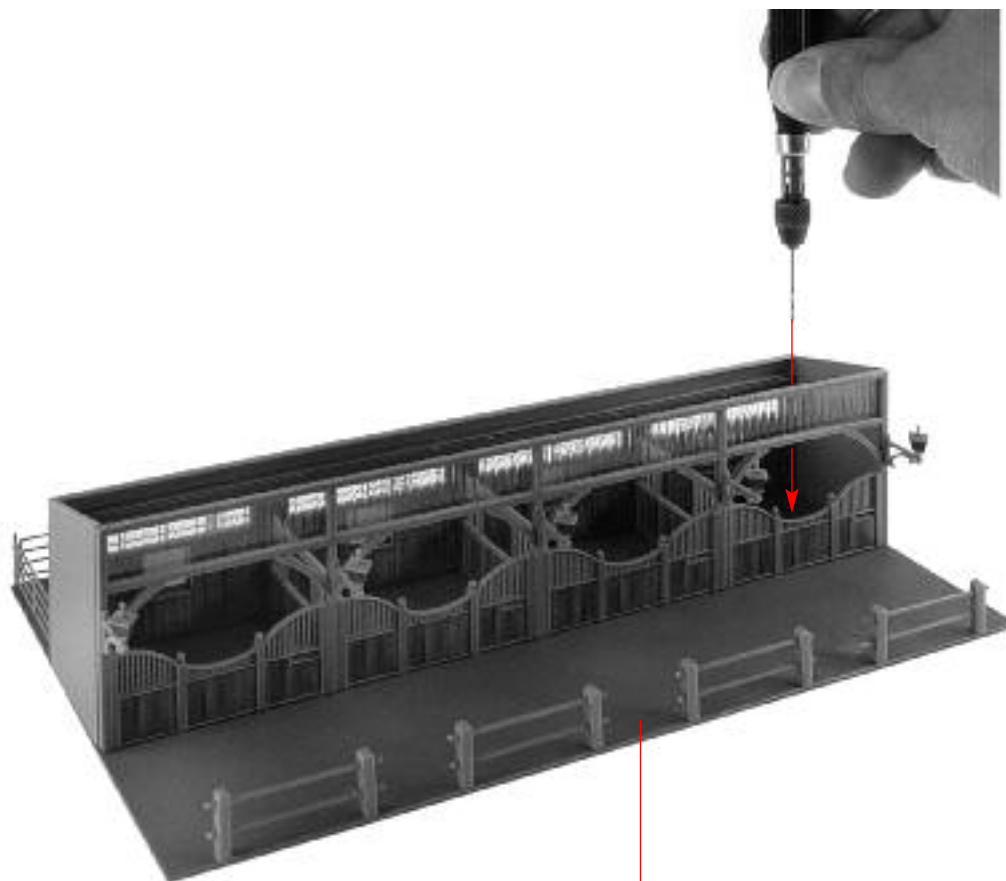
**i****f**

14

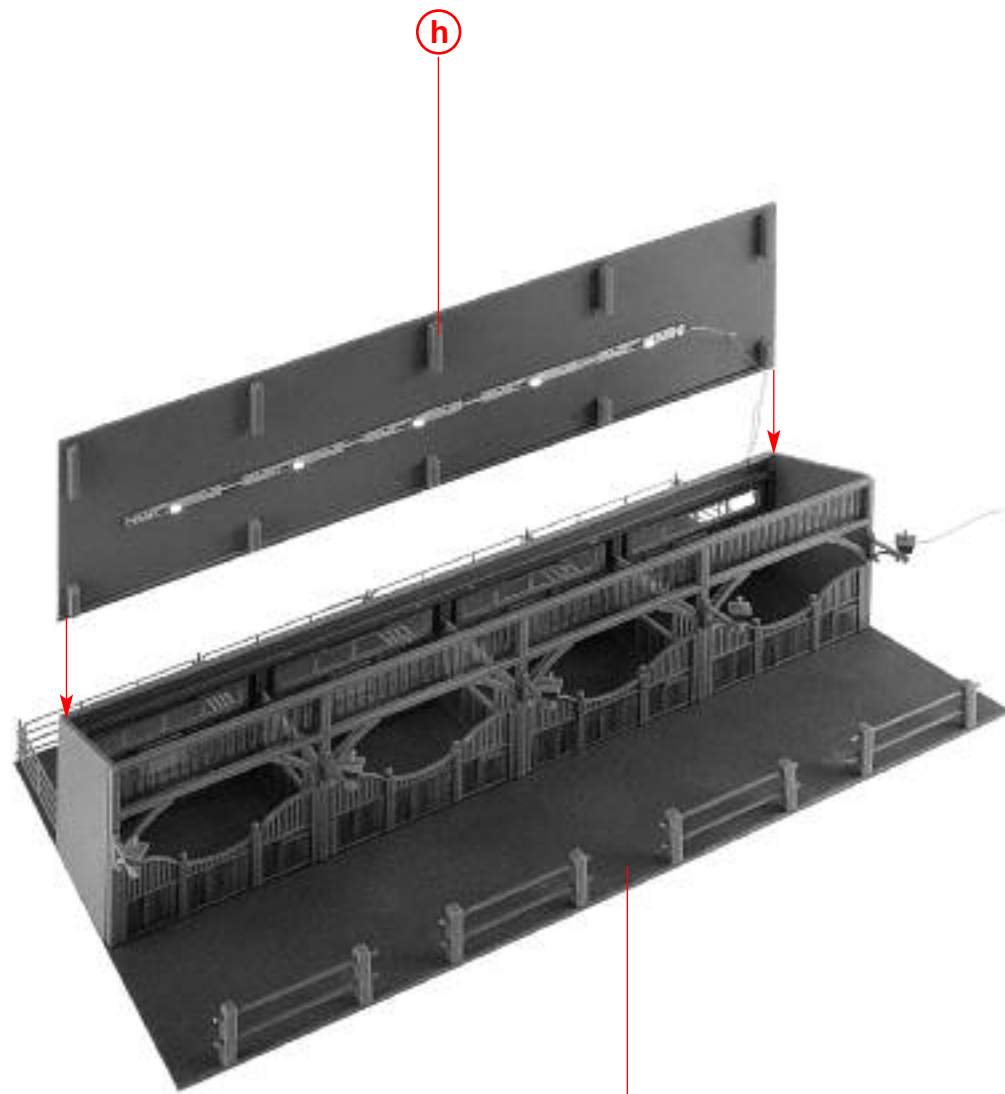

h

j

i

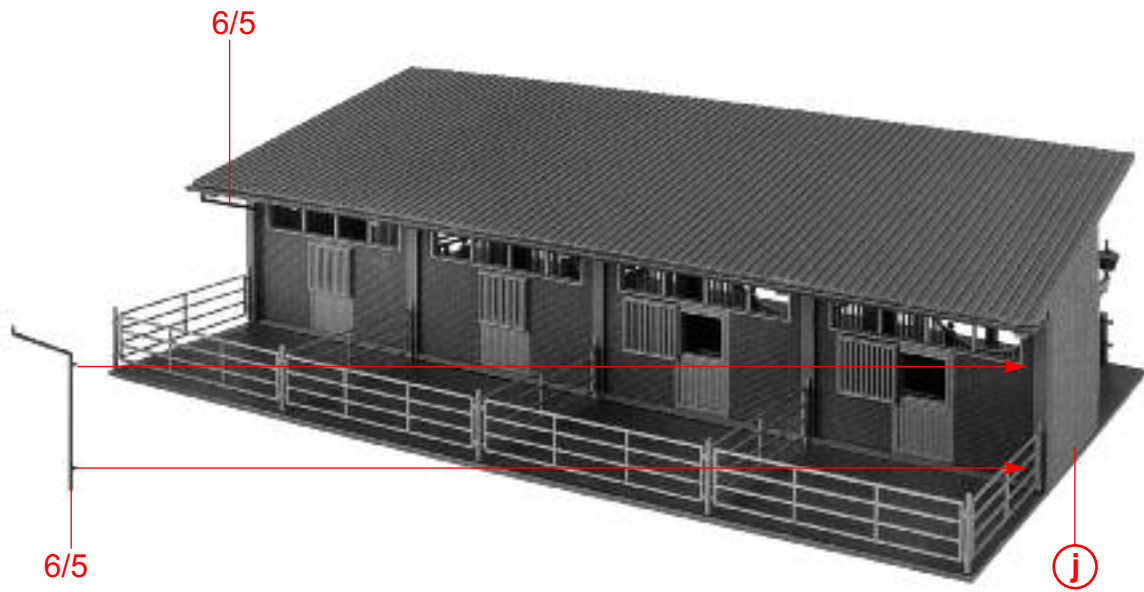

k

6/5

j

l

k

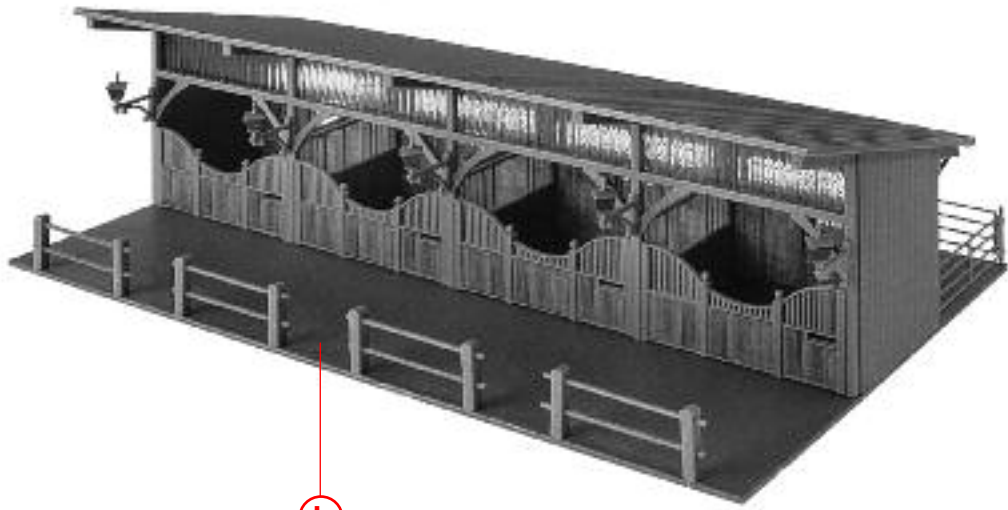

16

3/8

3/9

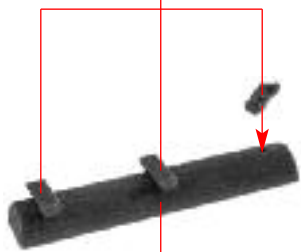

m

3/10

n

m

o

Variante 2

l

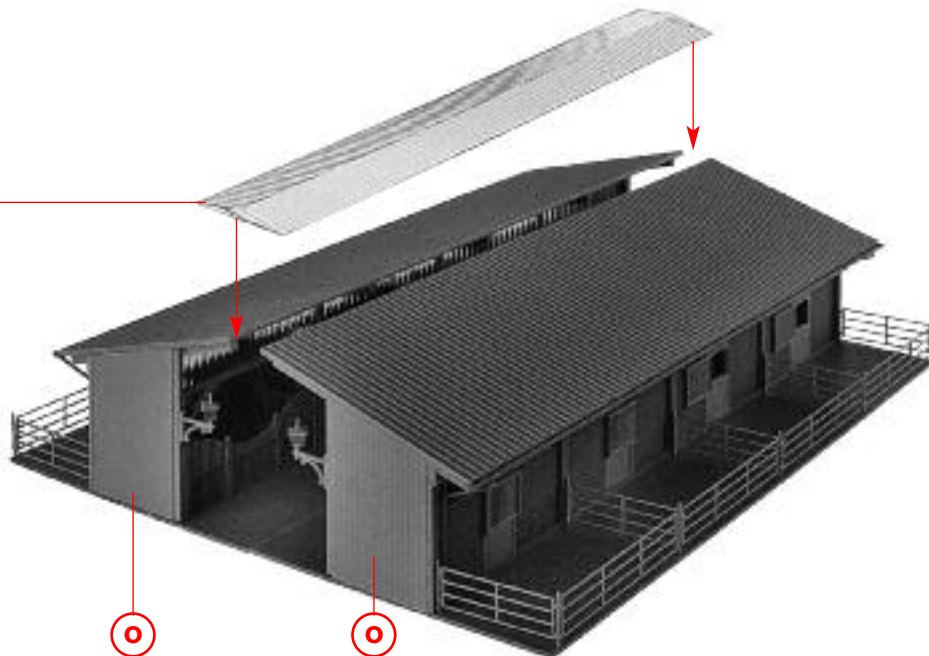
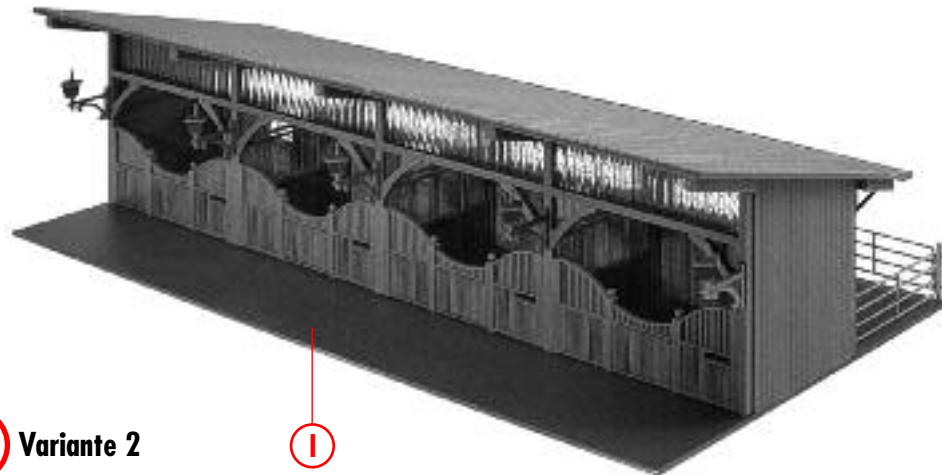

p

Variante 2

o

o