

# BISTRO »WINTERGARTEN«

BISTRO »WINTER GARDEN«

CAFÉ »WINTERGARTEN«

BISTRO »WINTERTUIN«



Art. Nr. 130509

**D**

Vor Beginn des Bastelns sollten Sie sich mit den Spritzlingen und der Anleitung vertraut machen. Sollte es einmal vorkommen, dass ein Teil im Bausatz fehlt, kreuzen Sie bitte das fehlende Teil in der Anleitung an und schicken Sie diese bitte an Fa. Gebr. FALLER GmbH, Abt. Kundendienst, kundendienst@faller.de, Kreuzstraße 9, 78148 Gütenbach. Sie erhalten dann umgehend Ersatz. In diesem Bausatz sind einige Kunststoffteile übrig.

**GB**

Before beginning with the assembly please familiarize yourself with the parts and read the instructions carefully. In case of missing parts please indicate these on the instructions leaflet with a circle and return the leaflet to Gebr. FALLER GmbH, kundendienst@faller.de, Kreuzstraße 9, D-78148 Gütenbach, Germany. You will receive the replacement by return. Some of the parts in this box are not needed to construct the model.

**F**

Avant de commencer le montage de votre maquette bien lire la notice et repérer les grappes. Si une pièce manque dans une boîte, cochez la pièce correspondante sur la notice et renvoyez-la-nous à Gebr. FALLER GmbH, kundendienst@faller.de, Kreuzstraße 9, D-78148 Gütenbach (R.F.A.). Nous vous ferons parvenir la pièce par retour. Dans cette boîte se trouvent quelques pièces qui ne seront pas utilisées pour le montage.

**NL**

Vóór het bouwen zou men de gielstukken en de handleiding moeten bestuderen. Indien onverhoopt een onderdeel aan het bouwpakket ontbreekt, gelieve men het ontbrekende deel in de handleiding aan te kruisen en deze te zenden aan Gebr. FALLER GmbH, kundendienst@faller.de, Kreuzstraße 9, D-78148 Gütenbach. U ontvangt dan omgaand en gratis het ontbrekende onderdeel. Van dit bouwpakket worden enkele kunststof delen niet gebruikt.

Für den Zusammenbau des Modells empfehlen wir folgende FALLER-Artikel (sind nicht im Bausatz enthalten):  
For the assembly of the kit we recommend following FALLER products (not included in the kit):  
Pour l'assemblage du modèle, nous vous recommandons les articles FALLER suivants (non inclus dans le kit):  
Om dit model te bouwen adviseren wij de volgende FALLER producten (maken geen deel uit van deze bouwset):



Art. Nr. 170492  
FALLER-EXPERT

Flüssigkleber in Plastikflasche mit Spezialkanüle für Feinste Klebstoffdosierung.

Liquid cement in plastic bottle with canule for very fine dosage.

Colle liquide en bouteille plastique avec bec verseur pour un dosage précis.

Vloeibare lijm in plastic-flescon met doseerbuisje om nauwkeurig te lijmen.



Art. Nr. 170688  
SPEZIAL-SEITENSCHNEIDER

zum gratfreien Abtrennen von feinsten Spritzteilen.  
Nur für Polystyrol geeignet.

Special side cutter for cutting off ultra-fine moulded parts without burrs.  
Only suitable for polystyrene.

Pince coupante spéciale pour couper sans bavure les pièces miniatures moulées par injection. Convient uniquement au polystyrène.

Speciale zijknijptang voor het braamloos afknippen van de fijnste gielstukdelen. Alleen geschikt voor polystyrol.



<b>Inhalt</b>	Spritzlinge	3	1 x	25 A	4 x	3	1 x
<b>Contents</b>	Sprues	4	1 x	25 B	2 x	3	1 x
<b>Contenu</b>	Moulages	5	1 x	2	1 x	8	1 x
<b>Inhoud</b>	Gielstukken						

Sa. Nr. 130 509 1

## 2

**Praktischer Tipp zum Anbringen der Fensterfolie:**

Die Fensterfolie genau ausschneiden und den zu beklebenden Fensterrahmen mit Klebstoff (FALLER Expert) benetzen.

Dann mit einem Stück zerknülltem Zellstoff (Toilettenpapier oder ähnlichem) vorsichtig abtupfen und anschließend die Fensterfolie exakt auflegen. Verschieben der geklebten Fensterfolie vermeiden.

Durch das Abtupfen wird eine gewisse Menge des Klebstoffes aufgesogen und die Klebestelle trocknet schneller ab. Diese Technik wirkt dem Kapillareffekt entgegen.

**Practical tip for application of the window foil:**

Cut the window foil thoroughly and moisten the window frame with glue (FALLER Expert).

Then dab with a piece of cellulose (toilet paper or similar) and attach the window foil exactly. Avoid moving the glued window foil.

Dabbing soaks up part of the glue and the glued part dries quicker. This procedure works against the capillary action.

**Astuce pour l'application de la feuille de décalcomanie:**

Découper soigneusement la feuille de décalcomanie, humecter la zone à coller en utilisant la colle FALLER EXPERT.

A l'aide d'un essuie tout tamponner délicatement le surplus de colle et appliquer avec exactitude la feuille de décalcomanie dans le cadre. Eviter de déplacer la feuille de décalcomanie après encollage .

Par le fait de tamponner la zone à encoller le surplus de colle sera absorbé, donc la zone à coller séchera plus vite. Cette technique agit contre l'effet de capillarité.

**Praktisch tip voor het aanbrengen van de vensterfolie:**

De vensterfolie op maat snijden en de te beplakken vensterramen voorzichtig met lijm (FALLER Expert) insmeren.

Dan met een stuk celstof (toilet papier of iets dergelijks) voorzichtig afbetten en vervolgens de vensterfolie op de exacte plek bevestigen. Vermijd het verschuiven van de folie.

Door het afbetten wordt een bepaalde hoeveelheid van de lijm opgezogen waardoor de lijmkleef sneller droogt. Deze techniek gaat het capillaire effect tegen.

### Decobogen aufziehen !

1. In einem flachen Teller eine Lauge aus Wasser mit 2 Tropfen Geschirrspülmittel ansetzen.
2. Schutzpapier von der Folie abziehen.
3. Folie mit der Klebeseite nach unten durch die Lauge ziehen.
4. Benetzte Folie auf die Oberseite der angegebenen Teile legen und ausrichten.
5. Mit einer Gummwalze, Spachtel oder weichem Tuch blasenfrei anreiben.
6. Gut durchtrocknen lassen !

### Montage de la feuille de décoration !

1. Dans une assiette plate préparer une lessive avec de l'eau et 2 gouttes d'agent de lavage de vaisselle.
2. Retirer le papier de protection de la feuille.
3. Tirer la feuille, la face adhésive tournée vers le bas, à travers la lessive.
4. Placer la feuille humidifiée sur la face supérieure des éléments en question et l'aligner.
5. L'appliquer sans soufflures avec un rouleau en caoutchouc, une spatule ou un chiffon moux.
6. Laisser bien sécher.

### Fitting the decoration sheet !

1. Use a flat plate and prepare a solution of water with two drops of dish-washing agent.
2. Pull off protective paper from sheet.
3. Pull sheet with its adhesive side down through the solution.
4. Place wetted sheet on the top of the specified parts and align it.
5. Rub it with a rubber roller, a putty knife or a soft cloth until it is bubble-free.
6. Allow it to dry well.

### Decoblad aanbrengen !

1. Neem een plat bord, doe daarop voldoende water en 2 druppels afwasmiddel.
2. Schutpapier van folie afnemen.
3. Folie met de lijmkant naar beneden door het water halen.
4. De natgemaakte folie op de bovenkant van de aangegeven delen leggen en op de juiste plaats schuiven.
5. Luchtbellen wegdrukken of wegwrijven met een zacht dockje, rubberrol of spatel.
6. Heel goed laten drogen.

4/4

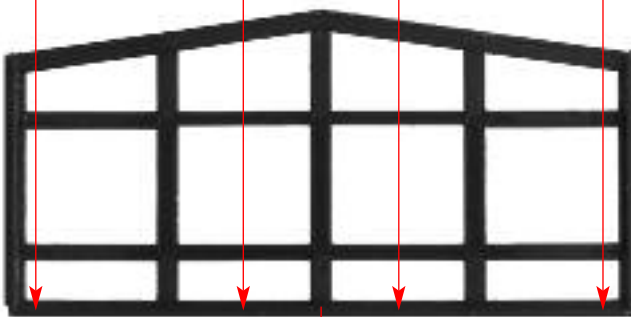
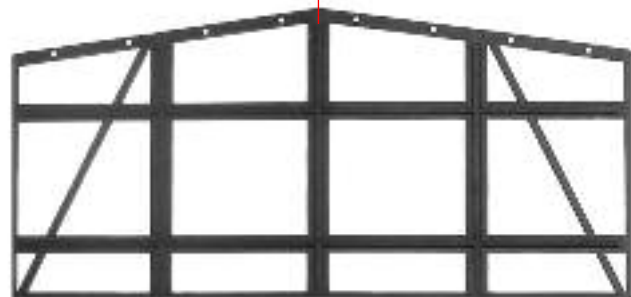

4/3

**A**

3

4/6

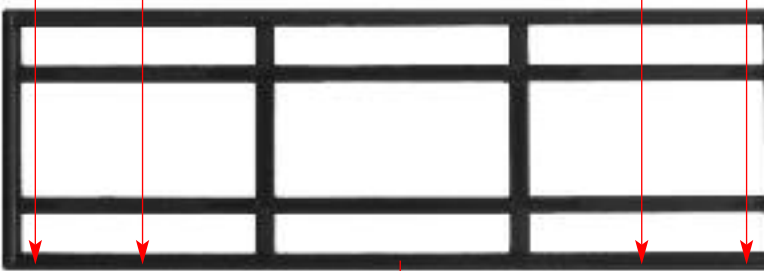

4/5

**B** 2 x

4

Fensterfolie 80 x 33 mm  
Window foil  
Feuillet transparent  
Vensterfolie

M1:1



4/1

(C)

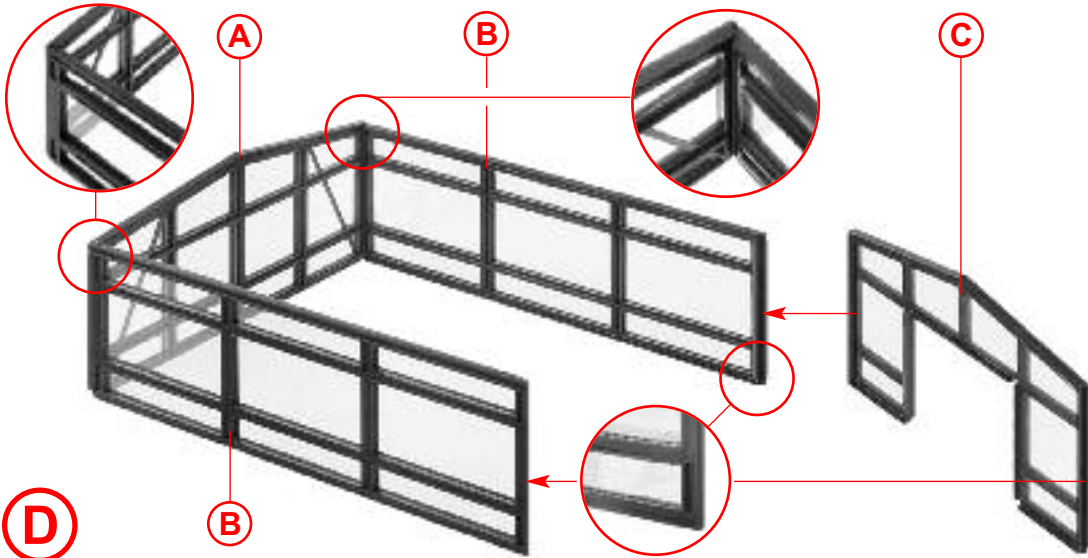

(D)

Deco 1

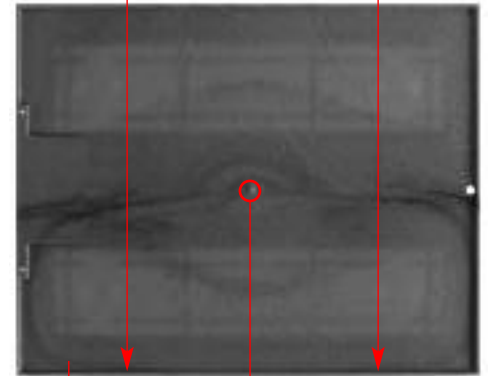
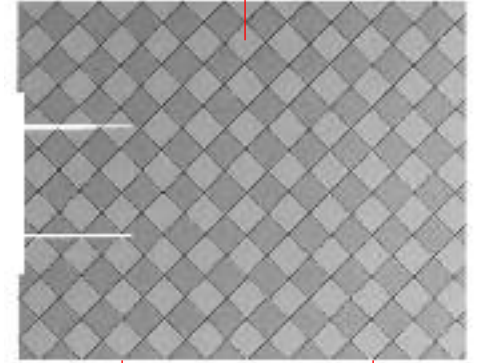

3/1

Abtrennen  
Separate  
Séparer  
Afknippen

(E)

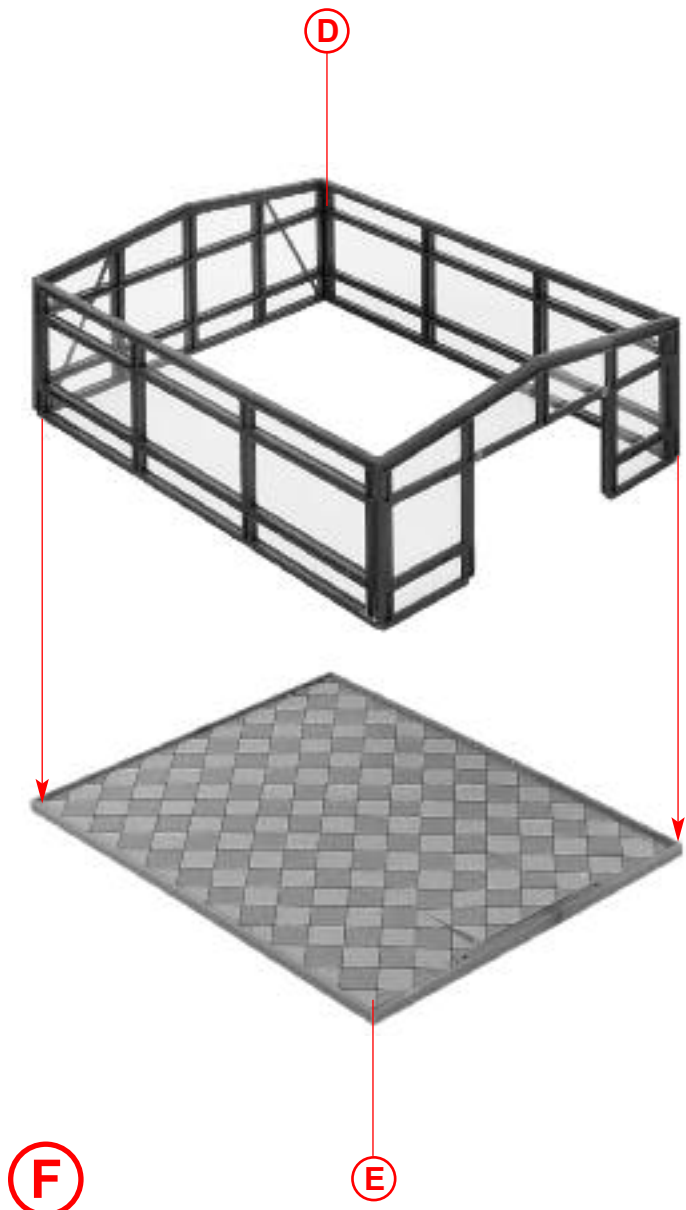

Fensterfolie 16,5 x 21 mm  
Window foil  
Feuillet transparent  
Vensterfolie

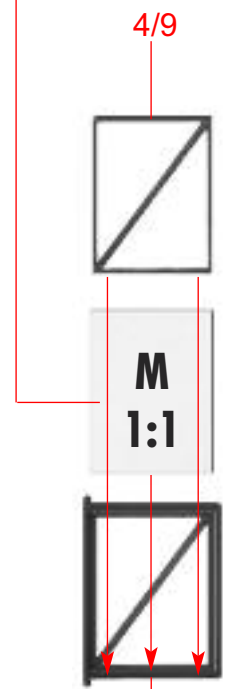

G 4/8

Fensterfolie 16,5 x 21 mm  
Window foil  
Feuillet transparent  
Vensterfolie

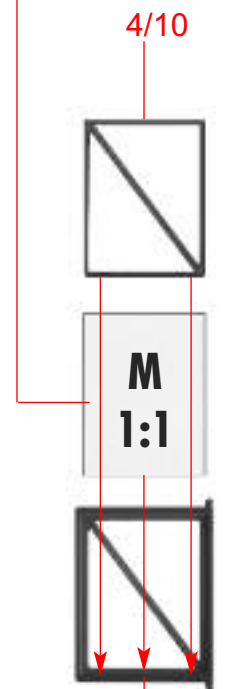

H 4/7

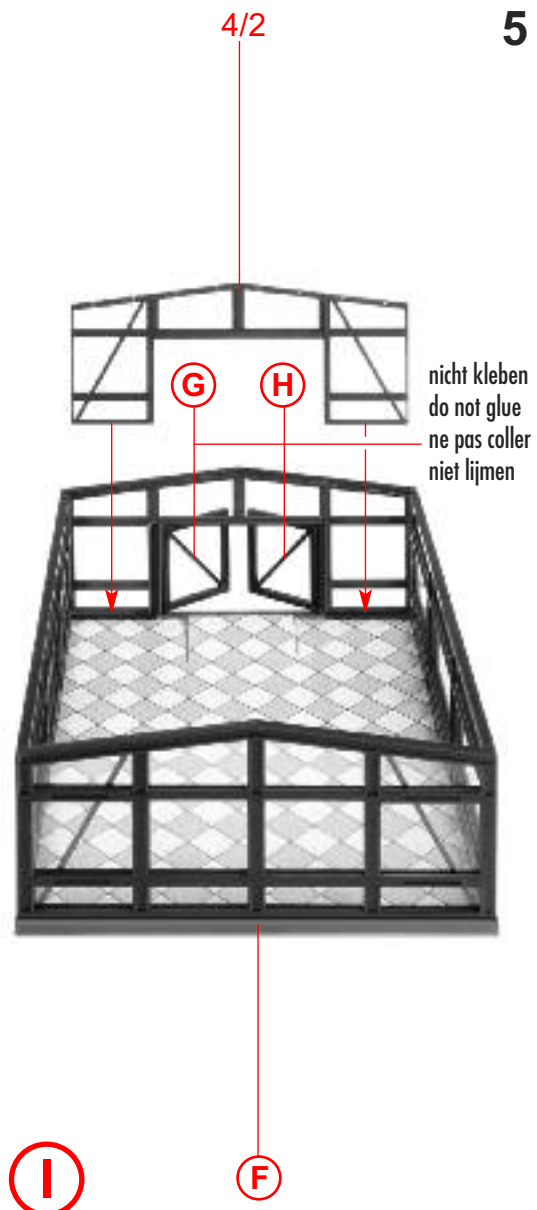

6

Deco 9



**J** 3 x 8/29



**K** 3 x **J**



**L** 3 x **K**

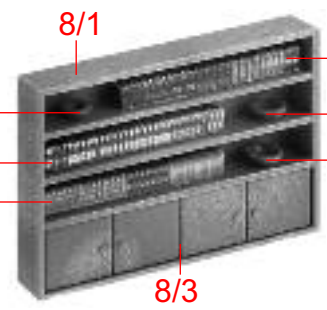

8/1  
2/3  
**L**  
**L**  
2/2  
2/2  
8/3  
**M**

8/18 Deco 10

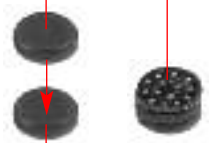

**N** 8/18

8/20 Deco 11

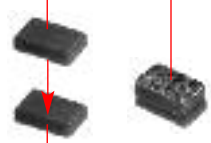

**O** 8/20

8/19



**P** 2/4

Inhalt	Tüte	Contents bag
Contenu	sachet	Inhoud
		zakje

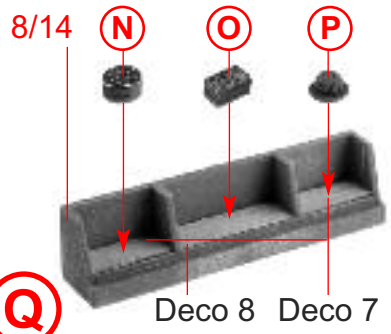

8/14 **N** **O** **P**  
**Q**  
Deco 8 Deco 7

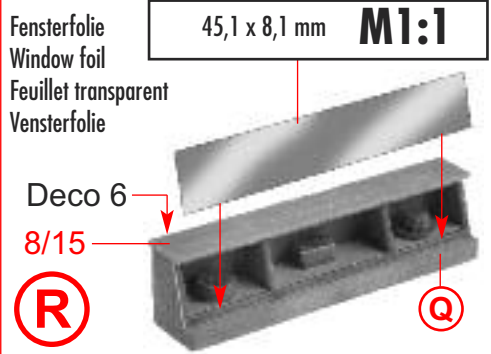

Fensterfolie  
Window foil  
Feuillet transparent  
Vensterfolie  
45,1 x 8,1 mm **M1:1**  
Deco 6  
8/15  
**R**  
**Q**

Deco 13



**S** 8/16

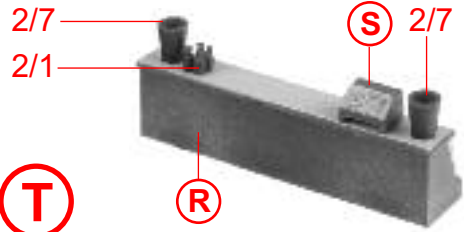

2/7  
2/1  
**S** 2/7  
**T** **R**

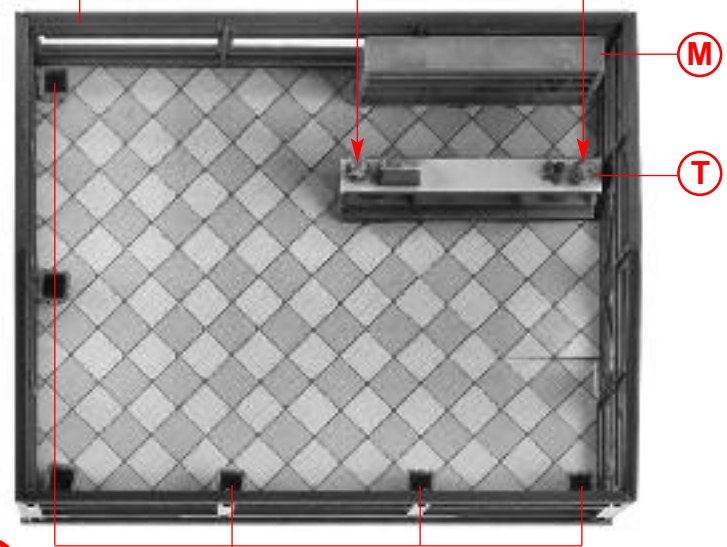

**I**  
**M**  
**T**  
**U**  
8/26

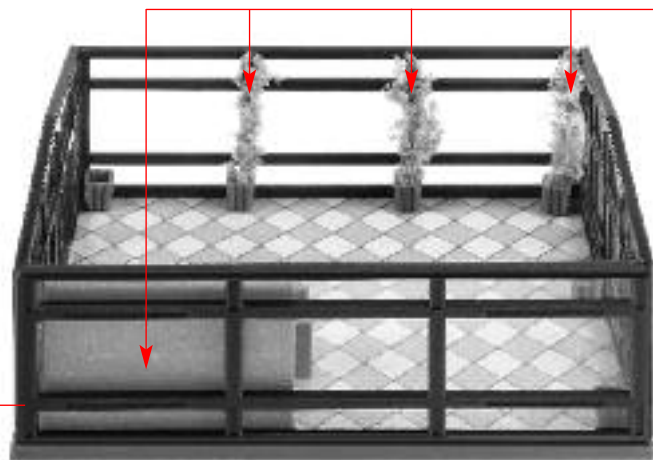

Inhalt Tüte  
 Contents bag  
 Contenu sachet  
 Inhoud zakje

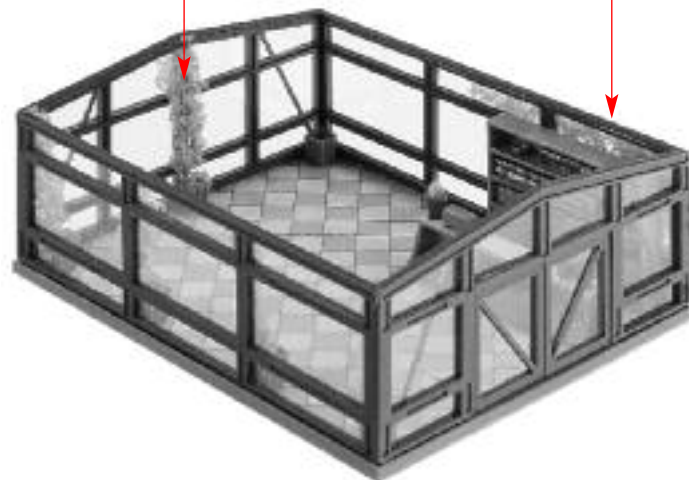

U

V

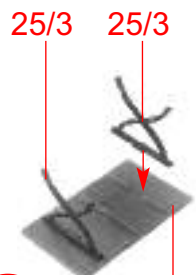

a 4 x 25/6

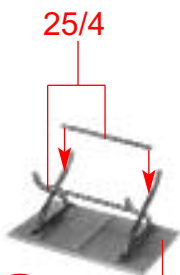

b 4 x a



c 2 x b



d 2 x b

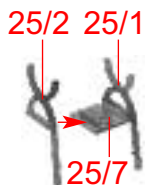

e 24 x

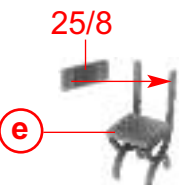

f 24 x



g



h 2 x

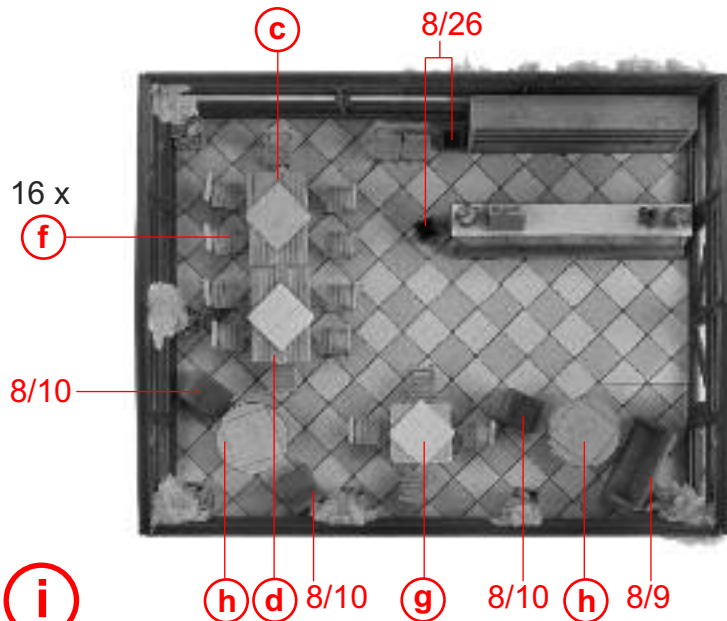

i

**8** Inhalt Tüte  
 Contents bag  
 Contenu sachet  
 Inhoud zakje



2 x  
2/6

4 x  
2/5

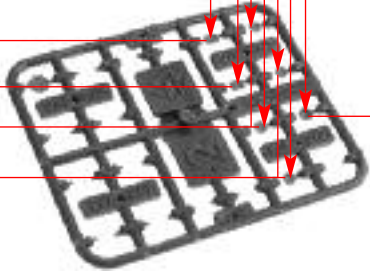

2/3

**j**

**j**

**j**

**k**

**i**

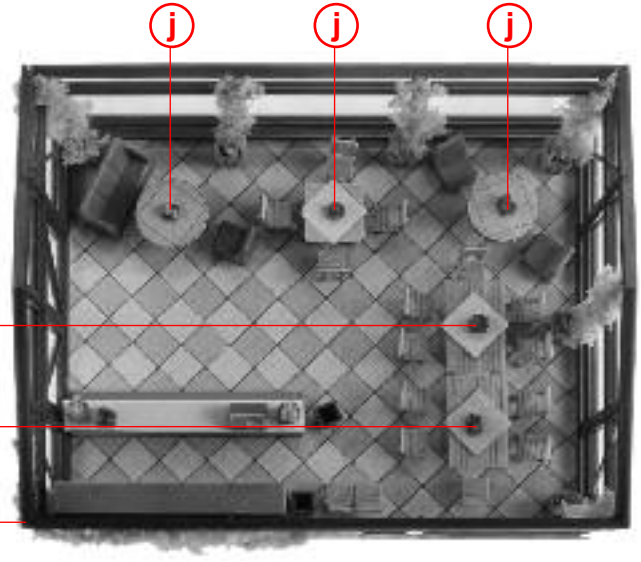

**l** 8 x

Draht  
Wire  
Etrier  
Draad  
104 mm

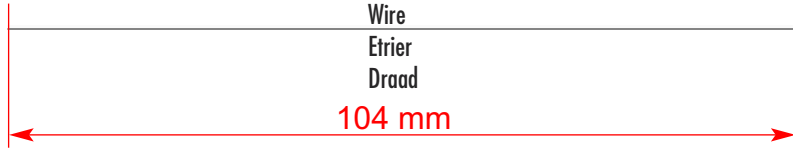

Papiermaske  
Papermask  
Masque  
Masker **M1**

**l**

**m** 4 x

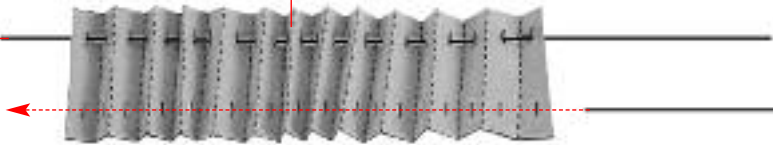

**l**





m



Sekundenkleber (FALLER EXPERT rapid 170500) verwenden.  
Use instant modelling cement (FALLER EXPERT rapid 170500).  
Utilisez la colle rapide (FALLER EXPERT rapid 170500).  
Gebruik secondenlijm (FALLER EXPERT rapid 170500).

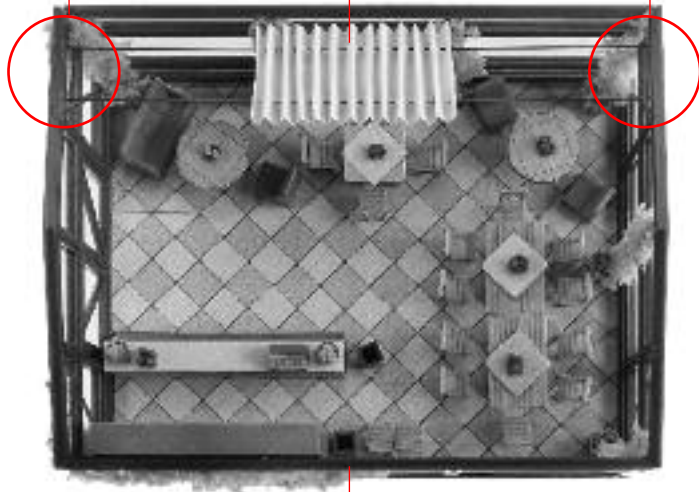

k

n

m

Sekundenkleber (FALLER EXPERT rapid 170500) verwenden.  
Use instant modelling cement (FALLER EXPERT rapid 170500).  
Utilisez la colle rapide (FALLER EXPERT rapid 170500).  
Gebruik secondenlijm (FALLER EXPERT rapid 170500).

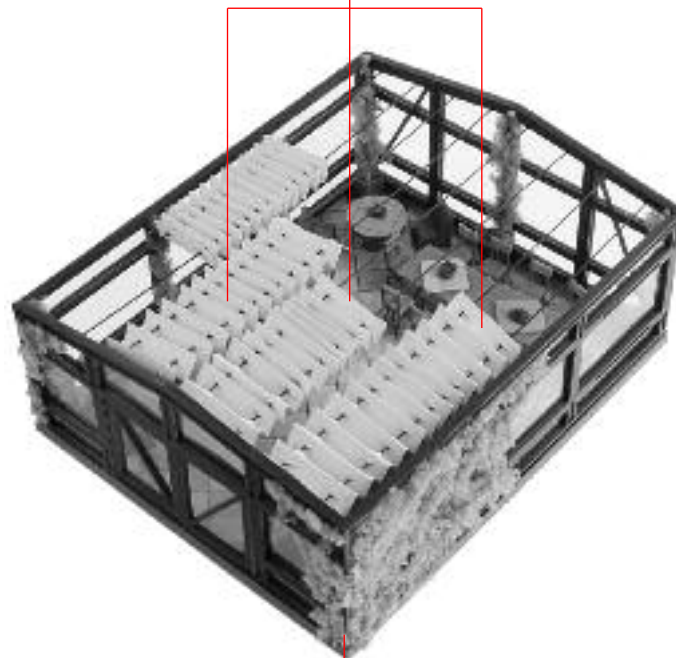

n

o

10

Deco 12

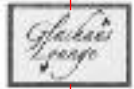

8/6

**p**

5/7

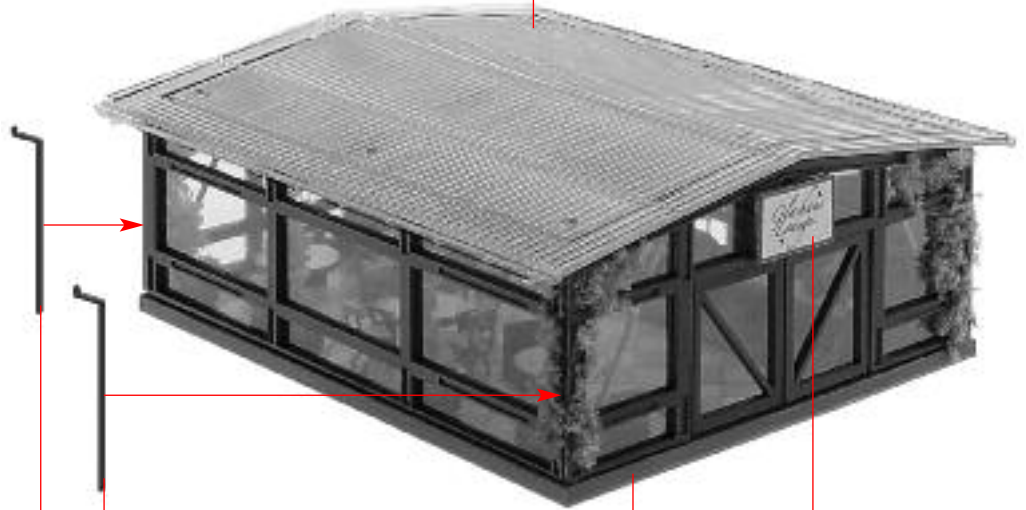

4/12

**q**

**o**

**p**

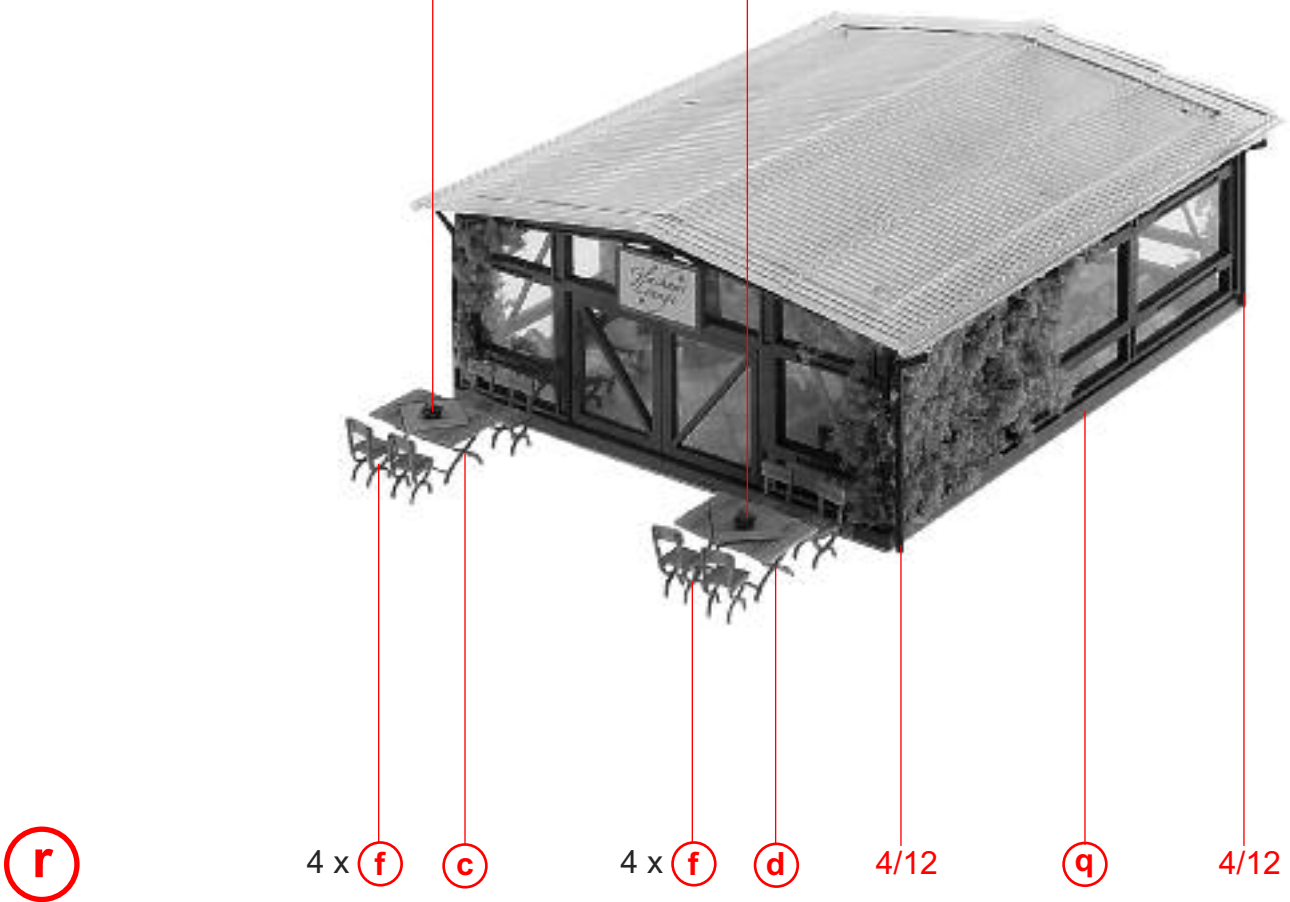

12

Deco 15

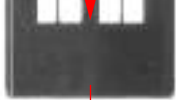

Fensterfolie  
Window foil  
Feuillet transparent  
Vensterfolie

grün  
green  
vert  
groen

3/4

s

Deco 16



Fensterfolie  
Window foil  
Feuillet transparent  
Vensterfolie

grün  
green  
vert  
groen

3/2

t

s

t

3/3

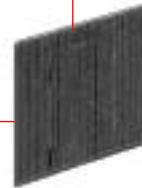
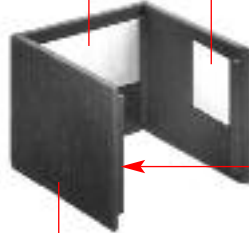

u

3/1

silber  
silver  
argent  
zilver

3/5

3/6



v

3/7

u

Deco 14

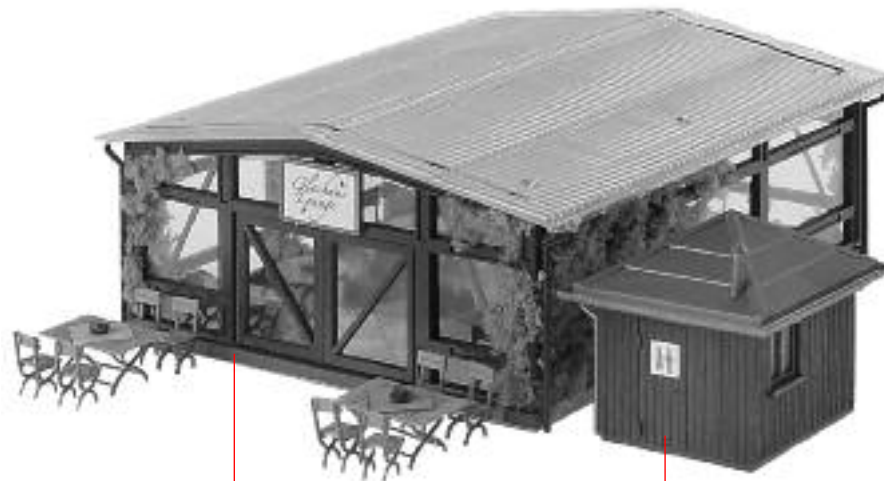

w

r

v